

General Purpose PT100 Temperature Sensors



These general purpose sensors can be used in most liquid and air applications. Compression fittings are also available for installation. These probes can be used as stand-alone sensors, or they can be configured with a variety of termination options, and combined with controllers, indicators, or precision thermometers to create complete measurement systems.

Specification

Material Body : Stainless steel AISI 316L (1.4404)

Sensing Elements: PT100 Platinum Elements per IEC751 ($\alpha = 0.00385 \Omega/\Omega/^\circ\text{C}$)

Accuracy : $\pm 0.03^\circ\text{C}$ to $\pm 0.3^\circ\text{C}$ depending upon class selection

Operating Temperature: from -200 to $+ 650^\circ\text{C}$ selection dependant

Output: Pt100

Cable Type: Selection – PFA-Silicone-PVC-Fibreglass

Protection: IP65

Accessories



Enclosures



4/20mA Transmitters



Fittings



Controllers

Sensor Configuration/Assembly

Termination Heads

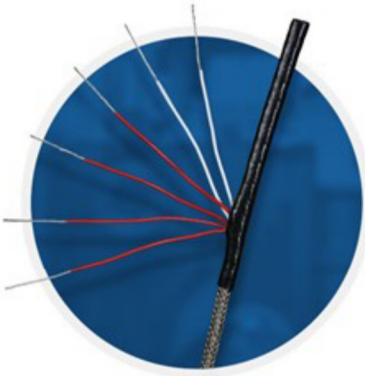

PVC

-10C to 105C

Good general purpose insulation for medium temperature environments. Waterproof and very flexible.

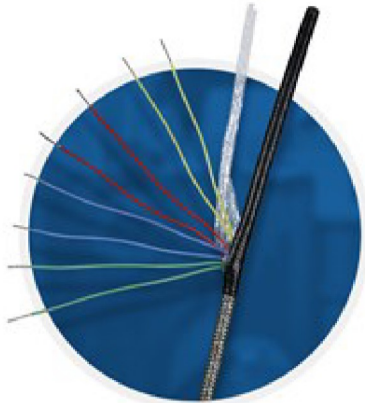

PTFE

-260C to +260C

Resistant to oils, acids, other adverse agents and fluids. Good mechanical strength and flexibility.

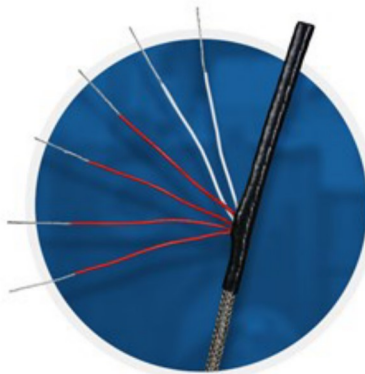

Silicone Rubber

-50 to +200

Offers excellent dielectric strength and flexibility. Operation over a wide temperature range and ease of silastic bonding are other outstanding characteristics of silicone rubber cable.

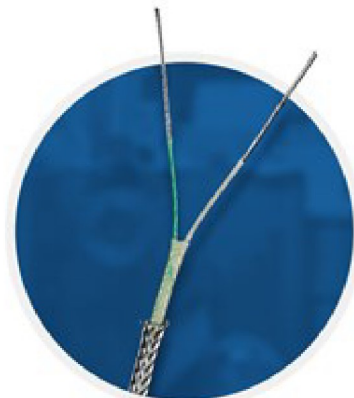

Glass fibre

(Varnished)

-60C to 350C

Good temperature range but will not prevent ingress of fluids. Fairly flexible but does not provide good mechanical protection.



Stainless Steel Flexible Conduit

withstands high temperatures

- Durable crush-proof construction
- Corrosion and rust resistant

Sensor Configuration/Assembly

Fittings

Type: UN

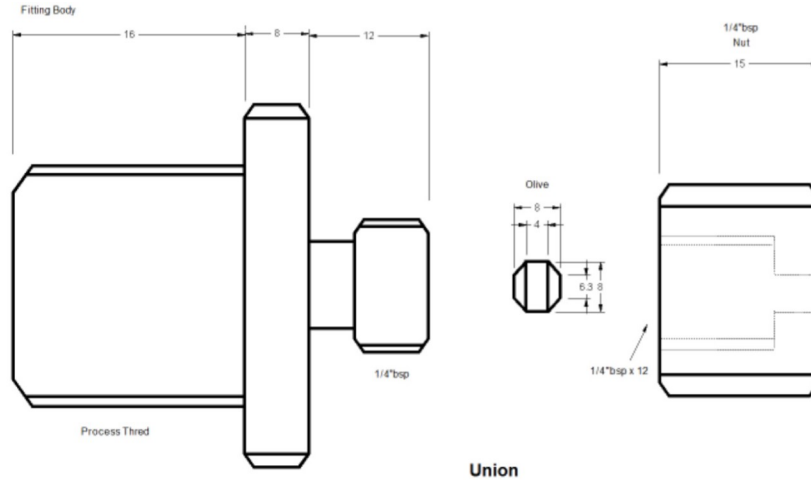

Type: DF

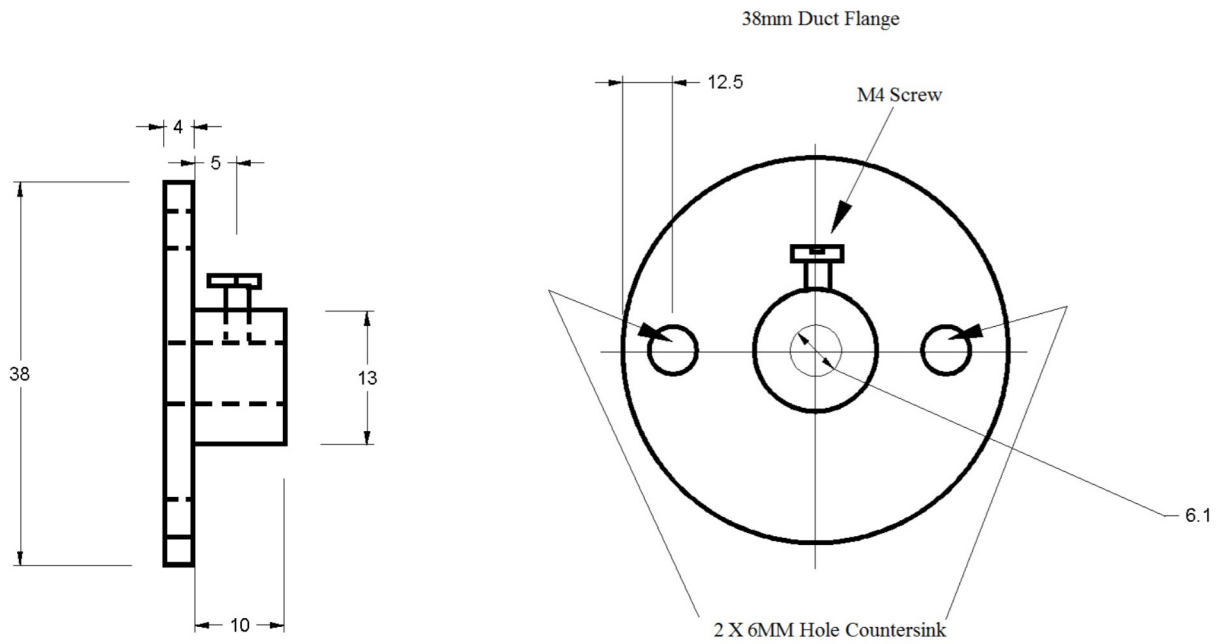

Type: FT

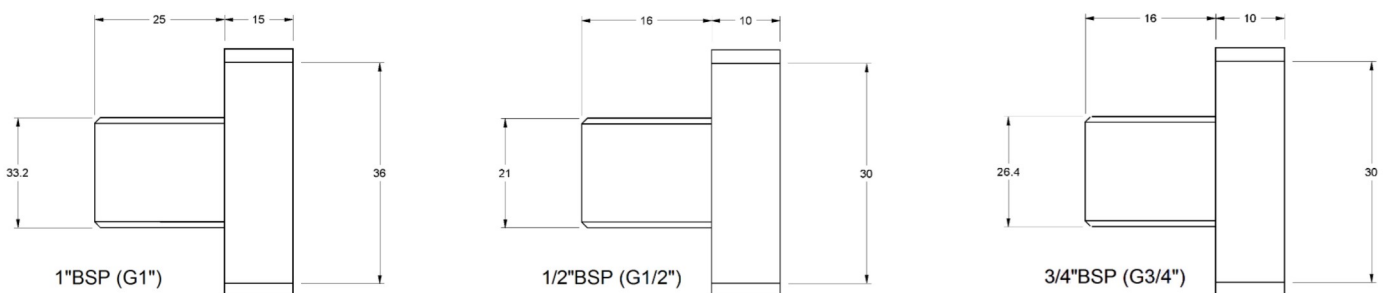

Wiring Configuration.

Two Wire

When accuracy is not critical, a two-wire RTD is the least expensive; offering. Using lead wires to place any distance between a two wire RTD and a receiving device will further compromise its accuracy. The potential for poor accuracy from a two-wire RTD stems from its inability to compensate for lead length, resistance that changes the ohm value of the original signal. A two-wire RTD should be used only in applications where the receiving device connects directly to the sensor

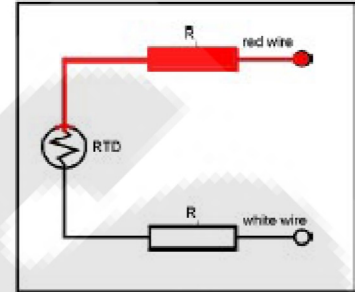

Three Wire RTD

Three-wire RTD's compensate for resistance resulting from length differences by adding a third lead to the RTD. To accomplish this requires that the wires match exactly. Any difference in resistance between the lead wires will cause an imbalance, which will compromise the accuracy of the RTD. Lead length variance, work hardening or corrosion, and manufacturing irregularities are errors to avoid. Quality manufacturing is critical to insure balance of all three leads.

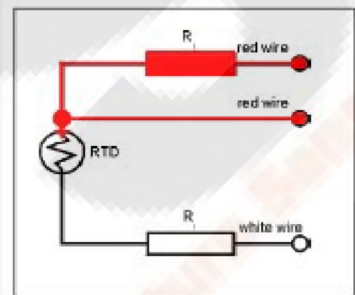

Four Wire RTD

Errors caused by resistance imbalance between leads are cancelled out in a four-wire RTD circuit. Four-wire RTD's are used where superior accuracy is critical or if the sensor is installed far from the receiving device. In a four-wire RTD one pair of wires carries the current through the RTD the other pair senses the voltage across the RTD. 2- and three-wire RTD's require heavier lead wire because thicker wire, by creating less resistance to the measured signal, reduces measurement distortion. Therefore lighter gauge wire, less expensive, may be used in four-wire RTD applications. RTD's are limited to temperatures of 1200 ° F and because of the construction of the sensing element, RTD's do not do well in high-vibration and severe mechanical shock environments. When selecting a temperature sensor for an application you should consult your temperature sensor manufacturer for recommendations.

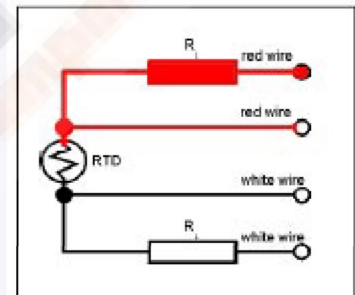

Accuracy, Stability, and Repeatability.

<u>Tolerance/Accuracy is calculated as:</u>	
Class B	change in $t = \pm (0.3 + 0.005 t)$
Class A	change in $t = \pm (0.15 + 0.002 t)$
1/3 Class B	change in $t = \pm 1/3 \times (0.3 + 0.005 t)$
1/5 Class B	change in $t = \pm 1/5 \times (0.3 + 0.005 t)$
1/10 Class B	change in $t = \pm 1/10 \times (0.3 + 0.005 t)$
t = absolute temperature in °C. Where elements have a resistance of $n \times 100$ Ohms then the basic values and tolerances also have to be multiplied by n	

These three terms are often confused, but it is important to understand the difference.

- Accuracy. IEC standard 751 sets two tolerance classes for the accuracy of RTDs: Class A and Class B:

$$\text{Class A: } \Delta t = \pm(0.15 + 0.002 \cdot |t|)$$

$$\text{Class B: } \Delta t = \pm(0.30 + 0.005 \cdot |t|)$$

where:

$$|t| = \text{absolute value of temperature in } ^\circ\text{C}$$

Class A applies to temperatures from -200°C to 650°C , and only for RTDs with three- or four-wire configurations. Class B covers the entire range from -200°C to 850°C .

- Stability.** This is the sensor's ability to maintain a consistent output when a constant input is applied. Physical or chemical changes can cause calibration drift. The material that the platinum is adhered to, whether wound on a mandrel or on a substrate, can expand and contract, straining the wire. Drift rates conservatively specified by manufacturers are typically $0.05^\circ\text{C}/\text{yr}$.
- Repeatability.** Repeatability is the sensor's ability to give the same output or reading under repeated identical conditions.

Absolute accuracy is not necessary in most applications. The focus should be on the stability and repeatability of the sensor. If an RTD in a 100.00°C bath consistently reads 100.06°C , the electronics can easily compensate for this error. The stability of RTDs is exceptional, with most experiencing drift rates of 0.05°C over a five-year period.

Response Time.

Response time varies according to the application. It is the sensor's ability to react to a change in temperature, and depends on the sensor's thermal mass and proximity to the material being tested. For instance, an RTD sensor in a thermowell will react more slowly than the same sensor immersed directly into a process. RTD specifications will list the sensor's time constant, which is the time it takes for an RTD to respond to a step change in temperature and come to 63% of its final equilibrium value. Response times are calculated in water flowing at 0.2 m/s and in air flowing at 1 m/s. This gives a useful comparison of RTD sensor configurations.

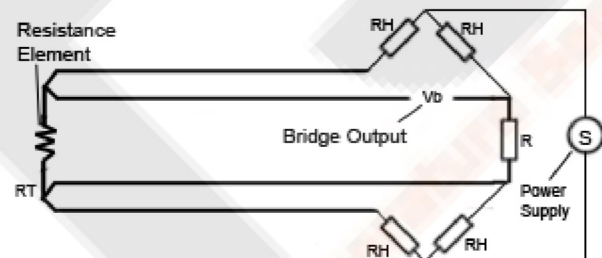

Figure 3. Lead wires have resistance that is a function of the material used, wire size, and lead length. This resistance can add to the measured RTD resistance, and improper wire compensation can result in significant errors. The common configurations of RTDs are two (A), three (B), or four wires (C).

RTD accuracy – Class A, Class B, 1/3 DIN, 1/10 DIN

ACTUAL	RTD ACCURACY +/- °C PT100 Ω ALPHA 0.003850 to DIN 43760 IEC751 DIN EN 60 751			
	B GRADE	A GRADE	BAND 3 (1/3 DIN)	BAND 5 (1/10 DIN)
-200 °C	1.30 °C	0.55 °C	0.39 °C	0.38 °C
-150 °C	1.05 °C	0.45 °C	0.23 °C	0.21 °C
-100 °C	0.80 °C	0.35 °C	0.15 °C	0.12 °C
-90 °C	0.75 °C	0.33 °C	0.14 °C	0.10 °C
-80 °C	0.70 °C	0.31 °C	0.13 °C	0.09 °C
-70 °C	0.65 °C	0.29 °C	0.12 °C	0.08 °C
-60 °C	0.60 °C	0.27 °C	0.11 °C	0.07 °C
-50 °C	0.55 °C	0.25 °C	0.10 °C	0.06 °C
-40 °C	0.50 °C	0.23 °C	0.10 °C	0.06 °C
-30 °C	0.45 °C	0.21 °C	0.09 °C	0.05 °C
-20 °C	0.40 °C	0.19 °C	0.09 °C	0.04 °C
-10 °C	0.37 °C	0.17 °C	0.08 °C	0.03 °C
0 °C	0.30 °C	0.15 °C	0.08 °C	0.03 °C
10 °C	0.35 °C	0.17 °C	0.09 °C	0.04 °C
20 °C	0.40 °C	0.19 °C	0.10 °C	0.04 °C
30 °C	0.45 °C	0.21 °C	0.11 °C	0.05 °C
40 °C	0.50 °C	0.23 °C	0.12 °C	0.06 °C
50 °C	0.55 °C	0.25 °C	0.13 °C	0.07 °C
60 °C	0.60 °C	0.27 °C	0.14 °C	0.08 °C
70 °C	0.65 °C	0.29 °C	0.16 °C	0.09 °C
80 °C	0.70 °C	0.31 °C	0.17 °C	0.10 °C
90 °C	0.75 °C	0.33 °C	0.18 °C	0.11 °C
100 °C	0.80 °C	0.35 °C	0.19 °C	0.12 °C
110 °C	0.85 °C	0.37 °C	0.20 °C	0.13 °C
120 °C	0.90 °C	0.39 °C	0.21 °C	0.14 °C
130 °C	0.95 °C	0.41 °C	0.22 °C	0.15 °C
140 °C	1.00 °C	0.43 °C	0.24 °C	0.15 °C
150 °C	1.05 °C	0.45 °C	0.25 °C	0.16 °C
160 °C	1.10 °C	0.47 °C	0.26 °C	0.17 °C
170 °C	1.15 °C	0.49 °C	0.27 °C	0.18 °C
180 °C	1.20 °C	0.51 °C	0.29 °C	0.19 °C
190 °C	1.25 °C	0.53 °C	0.30 °C	0.21 °C
200 °C	1.30 °C	0.55 °C	0.31 °C	0.22 °C